

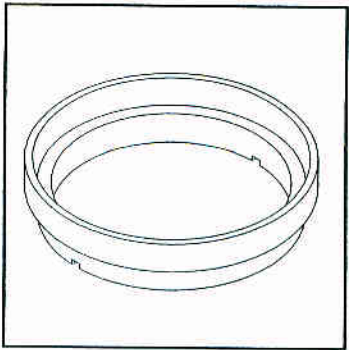

LIFTER RINGS

TF-101"

PLAN

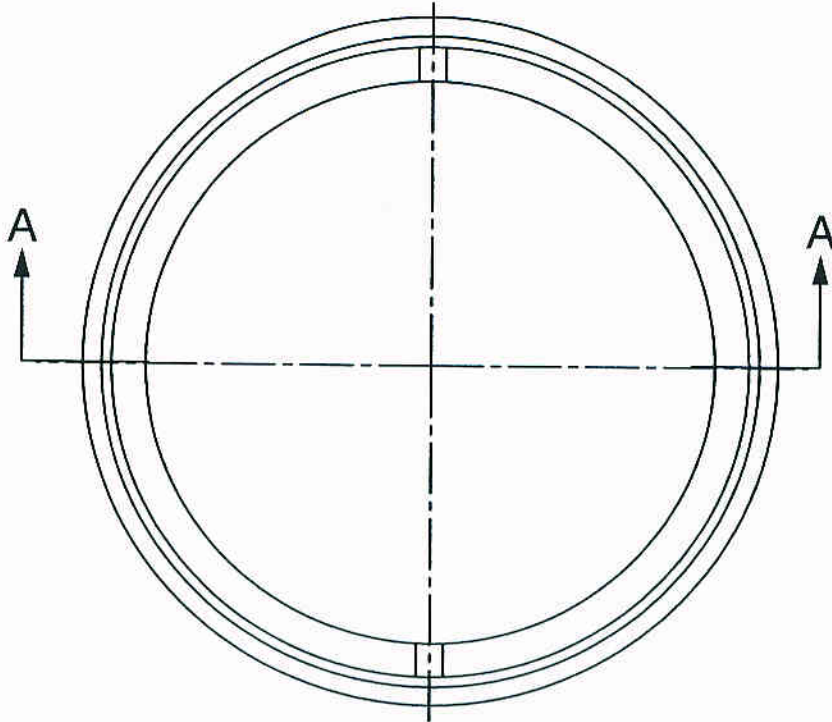

LIFTER RINGS DETAILS

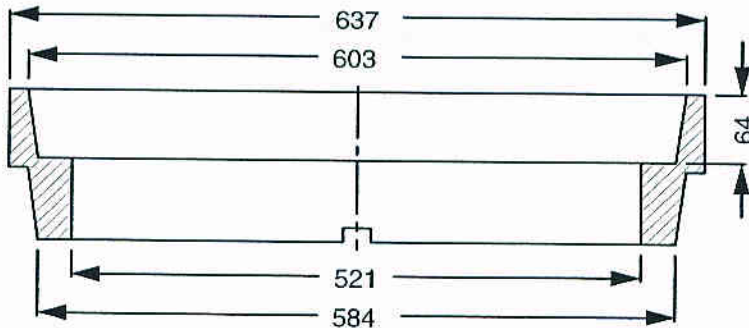
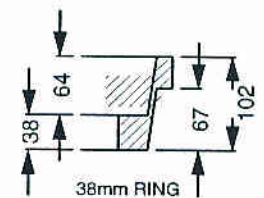
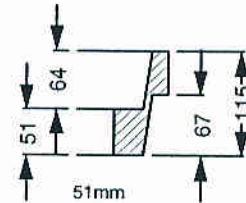
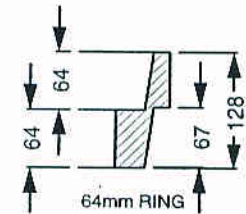
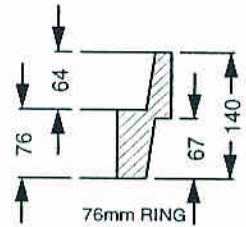

SECTION A-A

ISO 9001-2000 CERTIFIED

MEASUREMENTS IN MILLIMETERS

TITAN FOUNDRY

WINNIPEG, MANITOBA