



Please note that drawings are approximate and not to be used for engineering purposes – please contact us for specific dimensions.

STANDARD FRAME

TF-50

PLAN

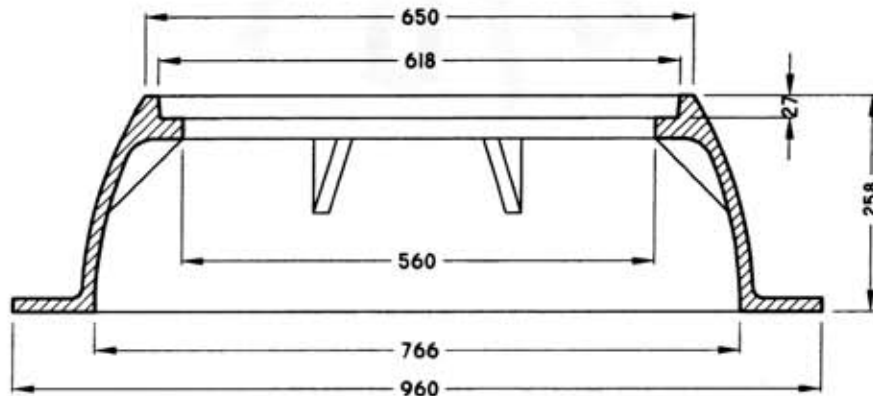
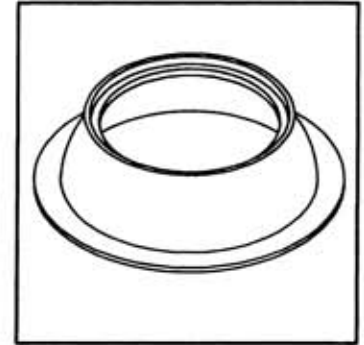
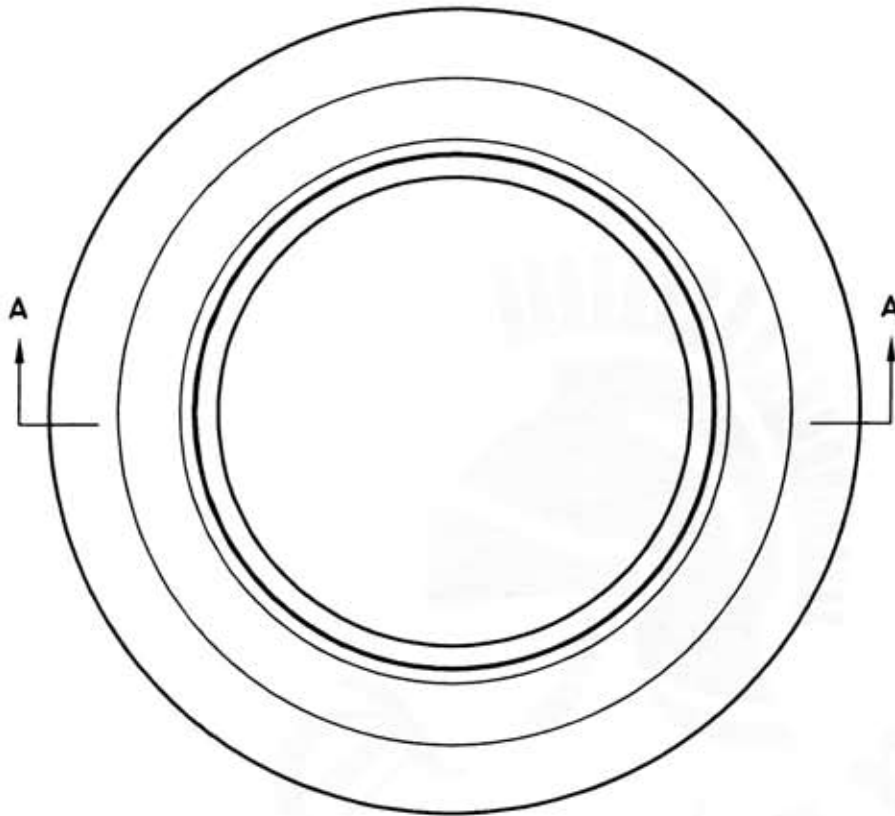

SECTION A-A

ISO 9001-2000 CERTIFIED

RATED FOR HS-20 LIVE LOAD

MEASUREMENTS IN MILLIMETERS

TROJAN INDUSTRIES INC.
CALGARY • EDMONTON, ALBERTA